

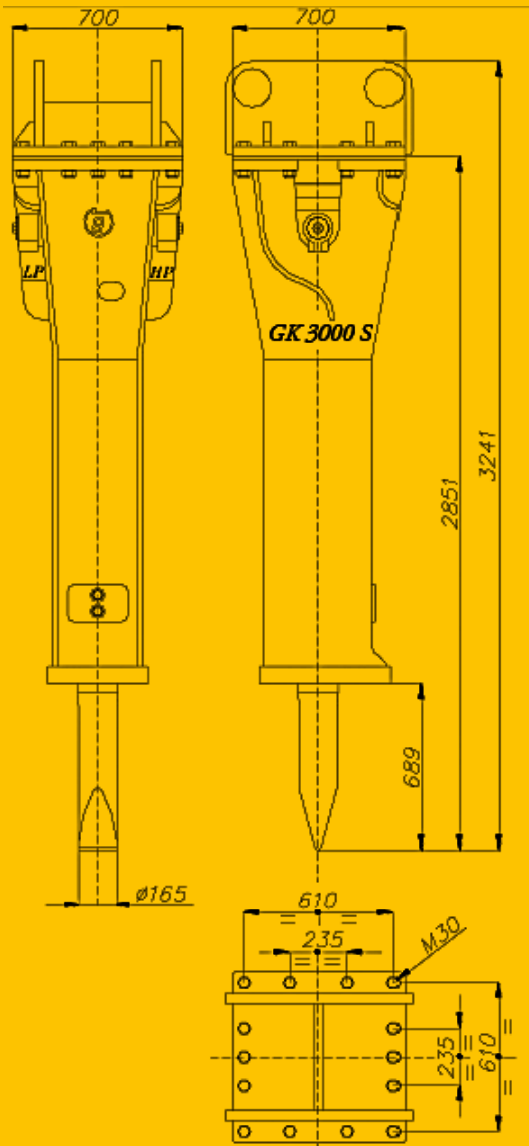

Italdem®

GK-3000 S HYDRAULIC BREAKER

OPERATING WEIGHT	3000 KG
TOOL DIAMETER	165 MM
OIL FLOW	250÷260 L/MIN
WORKING PRESSURE	150÷160 BAR
RELIEF VALVE	200 BAR
MAX BACKPRESSURE	12 BAR
BLOW ENERGY	6300 JOULE
REQUIRED POWER	93 HP
IMPACT RATE	500 (640)
CARRIER WEIGHT	30÷50 TON
MAX NOISE LEVEL (SILENCED)	88 DB-A
INNER DIAMETER HP LINE	32 MM
INNER DIAMETER LP LINE	38 MM



www.italdem.com