

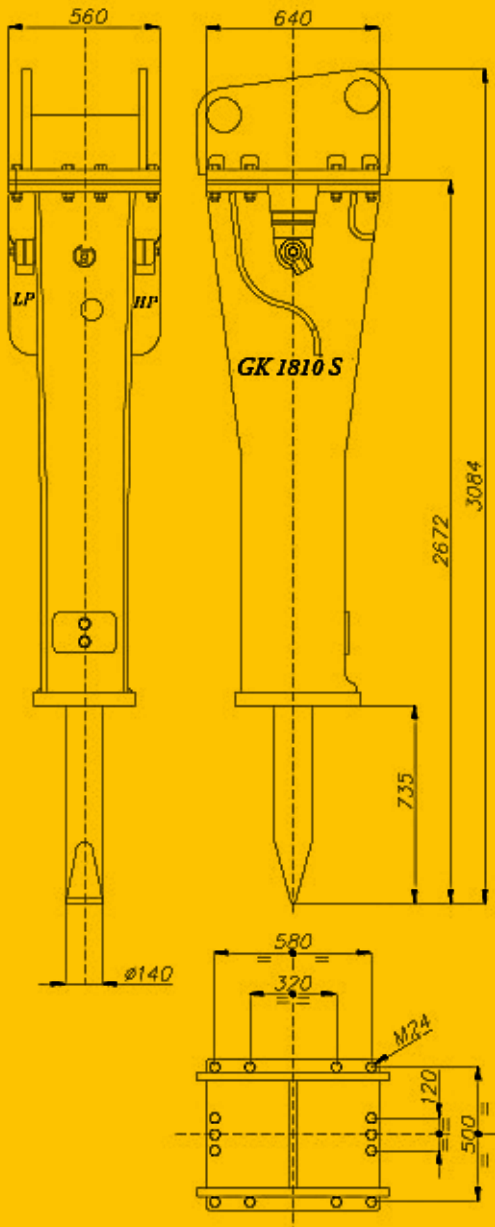

Italdem®



GK-1810 S HYDRAULIC BREAKER

OPERATING WEIGHT	1800 KG
TOOL DIAMETER	140 MM
OIL FLOW	200÷210 L/MIN
WORKING PRESSURE	140÷150 BAR
RELIEF VALVE	200 BAR
MAX BACKPRESSURE	12 BAR
BLOW ENERGY	4400 JOULE
REQUIRED POWER	70 HP
IMPACT RATE	550 (700)
CARRIER WEIGHT	22÷30 TON
MAX NOISE LEVEL (SILENCED)	88 DB-A
INNER DIAMETER HP LINE	26 MM
INNER DIAMETER LP LINE	38 MM

www.italdem.com